

IMPORTANT: IN THE INTEREST OF PRODUCT PERFORMANCE AND SAFETY PLEASE READ THESE INSTALLATION AND WARRANTY INSTRUCTIONS BEFORE INSTALLING THE PRODUCT.



SAL products are designed in accordance with all mandatory International and AS/NZS Standards, which require installation in accordance with AS/NZS3000 by a qualified installer and regular cleaning and maintenance of the equipment. Products are sold in accordance with the following instructions and SAL standard terms and conditions of sale, available via www.sal.net.au.



Due to continued product and information updates, product data sourced from sal.net.au shall not form part of any contract and or technical performance guarantee unless expressly confirmed in writing by SAL at the time of order.

PREMIER S9073TC S9074TC S9075TC S9076TC LED DOWNLIGHT electrical and installation specification effective 21/6/2021.

Model No.	Input (V)/(Hz)	Power (W)	Lumens (lm)	Line Current (A)	In-rush Current	Fitting Colour	CRI	Dimmable	Mass (N.W. kg)	Cutout Size (mm)	Dimension (mm)
S9073TC/WH/DP	220-240/50	13/18	1100/1300/1000 1500/1800/1600	0.05 0.08	10A Max.@230Vac, < 200µS at 50% Ipeak	White	> 80	Yes	0.35	Ø135	Ø165 x H63
S9073TC/SL/DP	220-240/50	13/18	1100/1300/1000 1500/1800/1600	0.05 0.08		Silver	> 80	Yes	0.35	Ø135	Ø165 x H63
S9074TC/WH/DP	220-240/50	15/20	1200/1400/1300 1600/1900/1700	0.06 0.08		White	> 80	No	0.45	Ø160	Ø200 x H68
S9075TC/WH/DP	220-240/50	23/30	2000/2300/2100 2600/3100/2800	0.10 0.13	20A Max.@230Vac, < 400µS at 50% Ipeak	White	> 80	No	0.55	Ø195	Ø230 x H75
S9076TC/WH/DP	220-240/50	30/40	2600/3100/2800 3500/4200/3800	0.13 0.17		White	> 80	No	0.7	Ø240	Ø280 x H96
S9074TC/WH/HP	220-240/50	10	1000/1100/1000	0.04	10A Max.@230Vac, < 200µS at 50% Ipeak	White	> 80	Yes	0.45	Ø160	Ø200 x H68
S9075TC/WH/HP	220-240/50	12	1300/1400/1400	0.05		White	> 80	Yes	0.55	Ø195	Ø230 x H75
S9076TC/WH/HP	220-240/50	18	2100/2300/2200	0.08		White	> 80	No	0.7	Ø240	Ø280 x H96

Electrical class	Driver II, Fitting III	Beam Angle	90°
Power factor	> 0.9	Earth Leakage current	< 1mA
Operating ambient min/max (°C)	0 to 40	Storage ambient limit (°C)	0 to 60
Operating humidity	+10% to 85% RH, NC	Storage humidity	+10% to 85% RH, NC
Reported TM-21, 85 °C, L ₉₀ (hrs)	> 36,000	Reported TM-21, 85 °C, L ₉₀ (hrs)	> 54,000
Aiming restrictions (if any)	N/A	Product application	Interior retail and commercial spaces
IK rating (if relevant)	N/A	Product installation orientation	Horizontal ceiling mount, recessed
CCT (K) switch control (TC)	Yes	CCT (K)	3000/4000/5700
Insulation cover rating (if any)	CA90	PIXIE connectivity	Yes, switch & dimming where noted above
Replaceable LED	No (see clause 8)	IP rating	IP64 from below ceiling, IP20 from above ceiling
User replaceable LED	No (see clause 8)	Attachment type	Fitting Z, driver X
IP rating for interior products: The designated IP rating is "from below the ceiling" unless otherwise specified.			
IP rating ALL products; Termination of the product must be made in accordance with the IP rating.			
Earth Leakage current: Is calculated in accordance with AS/NZ 60598.1.2017/Amdt 1:2017.			

General product application requirements (if applicable) :

- CCT or POWER selections (where supplied)** – IMPORTANT, where CCT colour temperature or POWER selection switching is provided, it is important to switch OFF the power before the selection is made, otherwise equipment damage may occur.
- Recycling** – SAL encourages recycling, please consider the environment when disposing of packaging, batteries & components.
- Switching or test intervals** – For optimum product performance, good design practice does not encourage 24/7 operation of lighting products without the provision of a routine switching or regulatory test cycle. As a guide for continual operation installations, a twelve (12) hour duration for Industrial and Commercial applications and a six (6) hour duration for Residential applications should be considered.
- Product maintenance** – In line with the relevant design standards and to protect your investment, it is important to have in place a routine cleaning program that reflects the installation environment and maintains the product in a clean and functional condition.

IMPORTANT - The supply must be isolated before any product maintenance or cleaning is conducted. In addition, damage to ANY cable or cord supplied with the product must be addressed as follows; For attachment type X having a specially prepared cable, if the external flexible cable is damaged, it must be replaced by an equivalent cable exclusively available from the manufacturer or authorised installer. For attachment type Y, if the external flexible cable is damaged, it must be exclusively replaced by an equivalent cable by the manufacturer or authorised installer. For attachment type Z, if the external flexible cable is damaged, the cable cannot be replaced and the luminaire must be destroyed.

- Adverse, corrosive and coastal installation environments** – Unless the product is specifically designated for such applications in these installation instructions, which is supported by a professional maintenance program; installation of equipment in such environments is not recommended.
- Dimming products** – Dimming circuits and product compatibility must be validated by the installer before installation; SAL cannot be responsible for third party changes in dimmer compatibility.
- Suspended products** – For installation safety, any suspended products must NOT be installed in high air movement spaces or locations subject to impact.



8. **Light source replacements** – (Non-replaceable light sources) - The light source of the product is deemed not replaceable, when the product reaches its end of life the complete product, it must be replaced by a qualified installer. (Non-user replaceable light sources) - The light source of the product must only be replaced by the manufacturer or qualified installer. **Caution, risk of electric shock.**

9. **Interior downlights and sensors with remote drivers and electrical accessories** – The mounting facilities provided for the transformer/driver (if any), need only be utilized if in the application of the product is required by AS3000. Drivers are not designed for installation environments that restrict conventional airflow.

10. **Floodlight products** – Unless nominated aiming restrictions or installation parameters apply, products are designed for installation environments between ground and 15 metres in height, subject to the desired optical performance being achieved. For floodlight installation environments that have restricted access (eg: columns and roof-lines) which are subject to unstable electrical supply or electrical surges (which void warranty), consideration of the installation of an independent surge protector is strongly recommended.

11. **Emergency enabled products** – In the interest of transport and safety, emergency products are supplied with the battery disconnected. In addition to specific emergency commissioning instructions, this battery **MUST** be connected at the time of installation.

12. **Specific installation procedures** (if any) - this device must be installed by a licensed electrician:

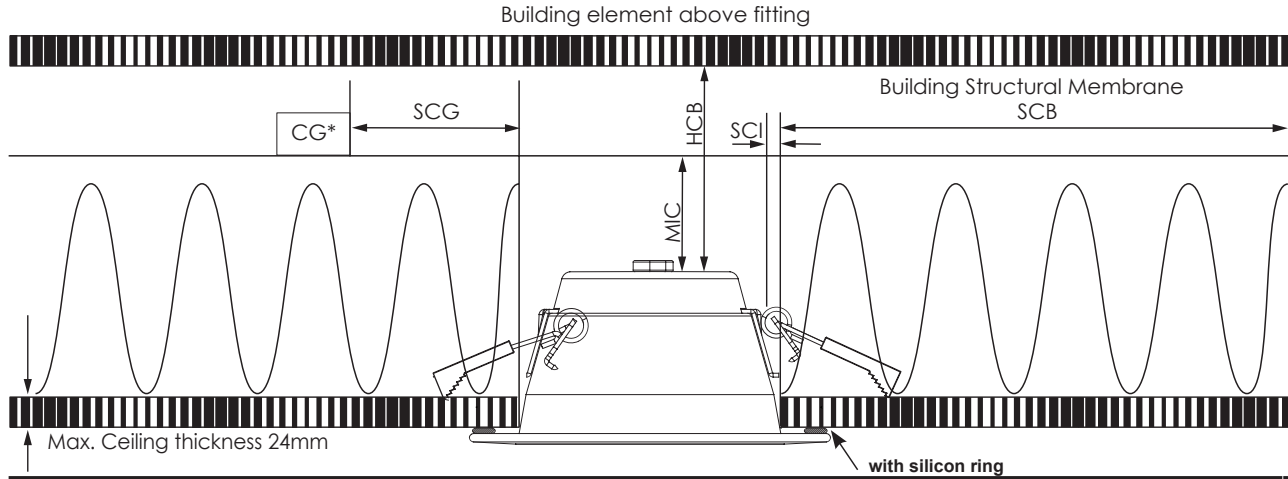

Definition - WARNING: RISK OF OVERHEATING OR FIRE IF THE CLEARANCE DISTANCES ARE COMPROMISED.	Clearance
HCB – The minimum clearance distance from the top of the luminaire to any normally flammable building element	50 mm
MIC – The minimum clearance distance from the top of the luminaire to any building insulation	50 mm
SCB – The minimum clearance distance from the side of the luminaire to any normally flammable building element	0 mm
SCI – The minimum clearance distance from the side of the side of the luminaire to any building insulation	0 mm
SCG – Side clearance to auxiliary equipment control gear (CG) (if supplied)	50 mm

NOTE: (1) CG* – Remote control gear provided (if any) must not be covered.

NOTE: (2) IC ratings shown (if any) are made in accordance with AS/NZS6058 test procedures that stipulate the type of insulated material composition covering an IC-4 rated product being equivalent to formed insulation, where 200mm is equivalent to an R1 4.0 classification in accordance with AS/NZ4859.1.

13. **Warranty** – In accordance with SAL's standard terms and conditions of sale, SAL warrant this product to be free from defects in materials and or workmanship for a period as stated below for goods not subject to incorrect installation, maintenance, operation, mishandling, environmental, unauthorised modifications or electrical operating conditions outside the nominated product specification as detailed in these installation instructions. The benefits to you given by this warranty are in addition to other rights and remedies you have under law. Our goods come with guarantees that cannot be excluded under the Australian Consumer Law. You are entitled to a replacement or refund for a major failure and compensation for any other reasonably foreseeable loss or damage. You are also entitled to have the goods repaired or replaced if the goods fail to be of acceptable quality and the failure does not amount to a major failure.

Warranty term – Residential usage (NA) months, Commercial usage (36) months and batteries where supplied (12) months from date of purchase. For New Zealand, please refer to www.sal.co.nz for warranty conditions and service.

How to make a claim?

Step # 1 – Within 30 days of the fault discovery, please contact the original place of the SAL product purchase during standard (local) business hours, with the following information **(a)** proof of purchase **(b)** description and quantity of the claimed fault **(c)** address of installation. **(d)** operating hours of the product.

Step # 2 – It is then the responsibility of the original place of product purchase to report the matter to SAL aftersales:

NSW ACT	- SAL National Pty Ltd, 40 Biloela Street Villawood NSW 2163	P # 02 9723 3099
QLD	- SAL National Pty Ltd, 36 Whitelaw Place Richlands QLD 4077	P # 07 3879 5999
VICT TAS SA NT	- SAL National Pty Ltd, 46-48 Keys Road Moorabbin Victoria 3189	P # 03 9532 3168
WA	- SAL National Pty Ltd, 29 Beringarra Av Malaga WA 6090	P # 08 9248 7458
NZ	- Hamer, 130 Bush Road, Albany, Auckland, 0632	P # 0800 239 239

Step # 3 – Upon review of your claim and if the product is required to be returned to SAL for technical evaluation, then at the owners expense the product must be returned to SAL as per the above nominated locations.

Step # 4 – Pending the evaluation, the claim will be validated resulting in the product being repaired or replaced with the same or best equivalent product at the discretion of SAL, or rejected if the product fault was found to be caused by conditions beyond the responsibility of SAL warranty obligations. Consideration of installation, product removal, return freight and or testing fees are not the responsibility of SAL.

